

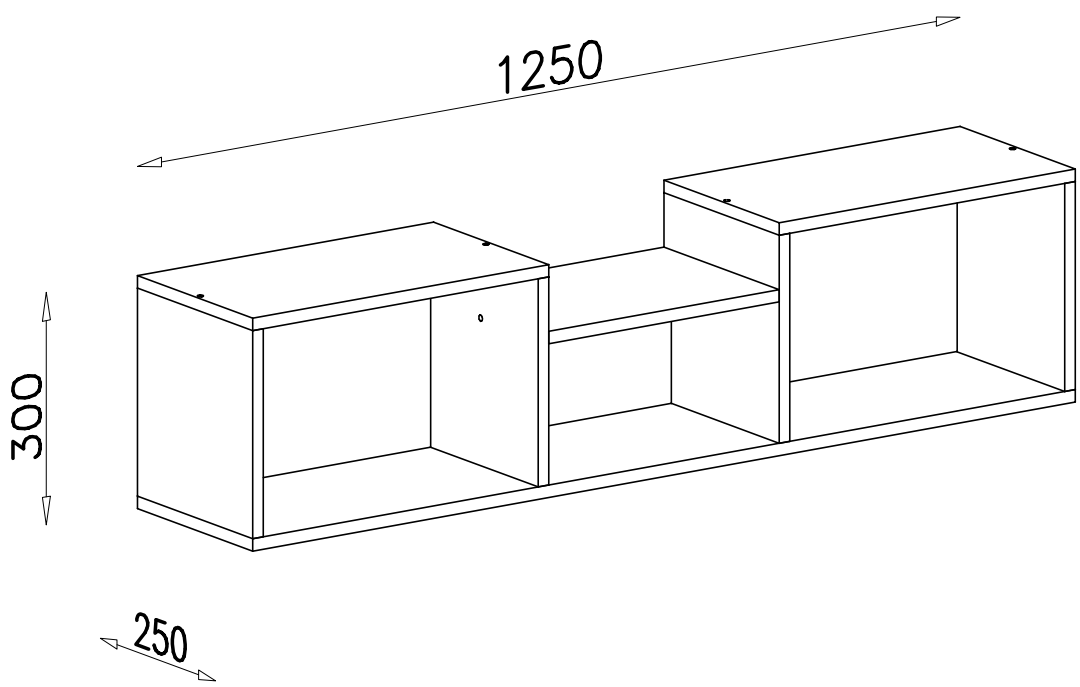

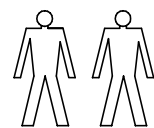

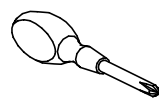

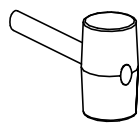
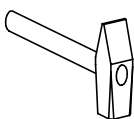
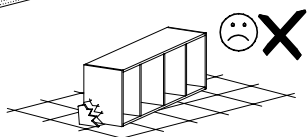
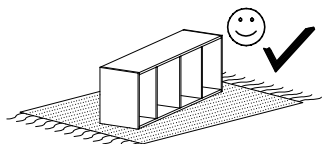

SERGIO SE 11

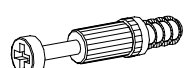

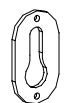
<p>I7 ø18 x6</p> 	<p>K5 x6</p> 	<p>K1 ø15x12 x6</p> 	<p>G4 4x16 x4</p> 	<p>U12 x2</p> 
<p>A1 ø7x50 x10</p> 	<p>B7 ø8x30 x32</p> 	<p>W2 x1</p> 	<p>W1 GLUE, LEIM, LEPIDLO, LIM x2</p> 	<p>U4 x2</p> 

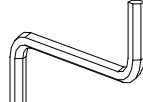

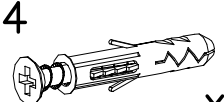
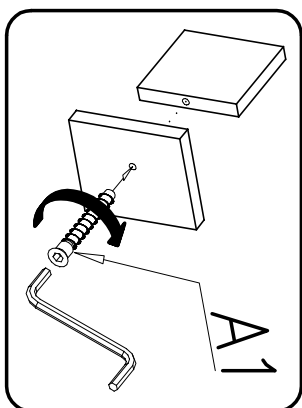
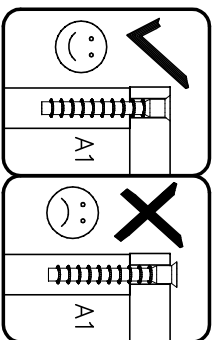
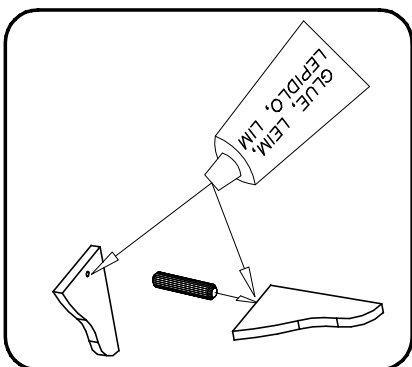
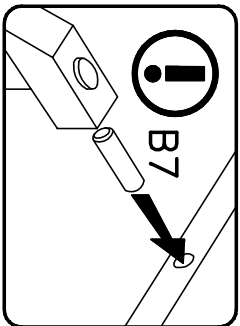
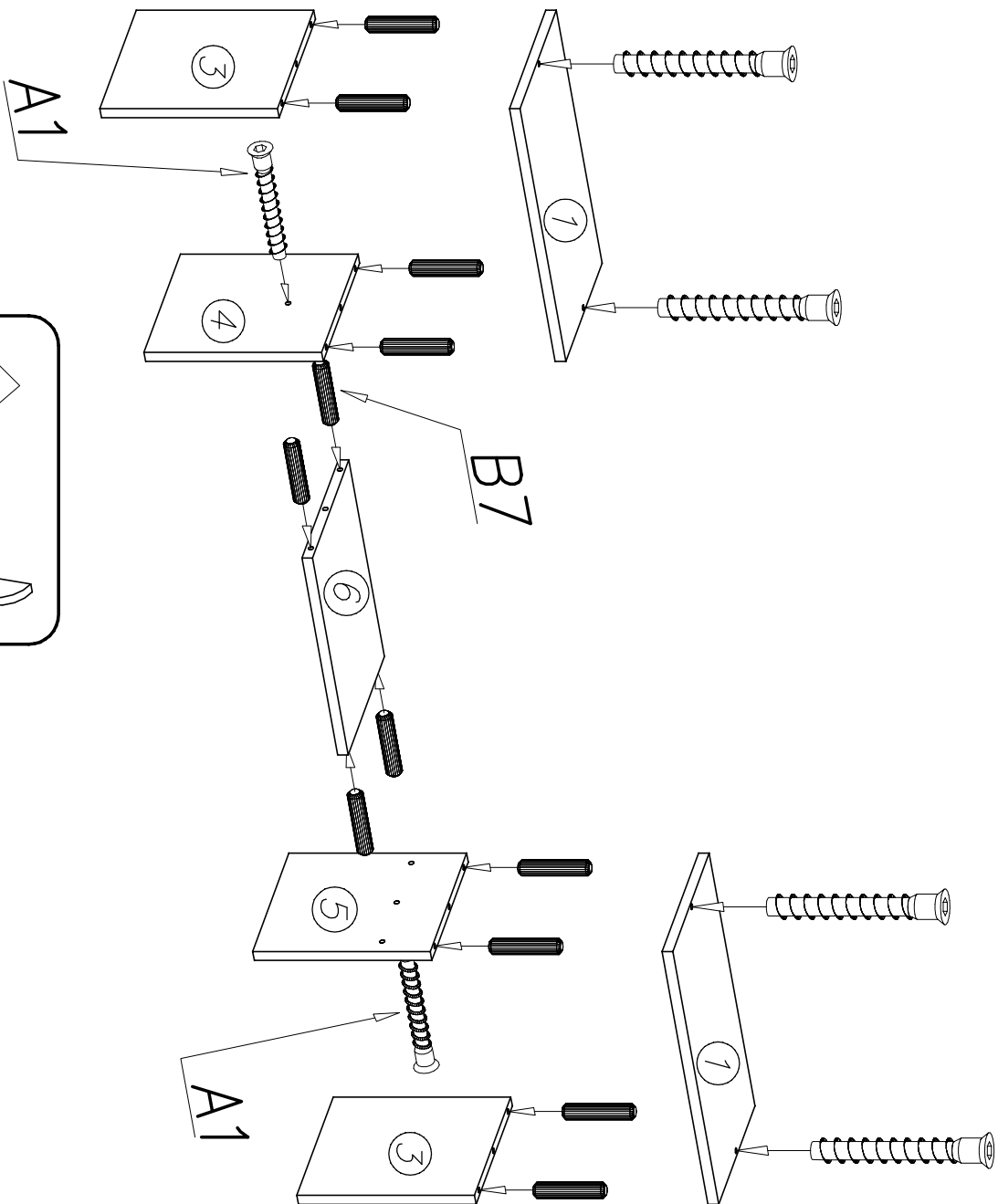
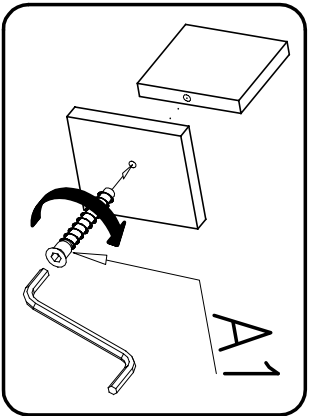
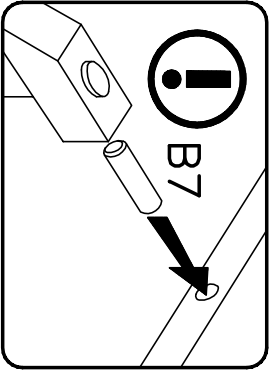
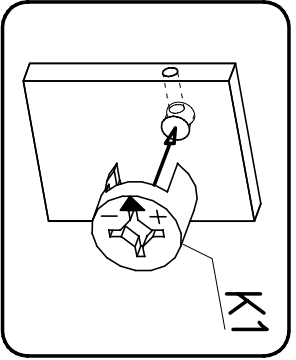
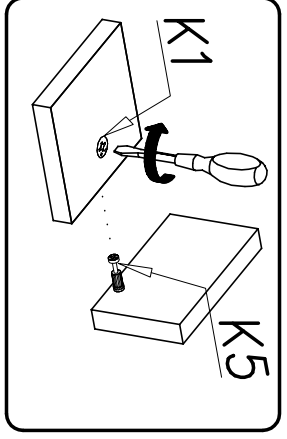
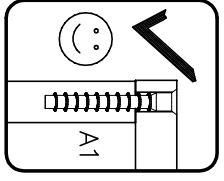
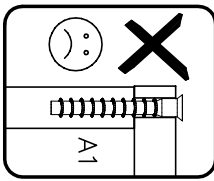
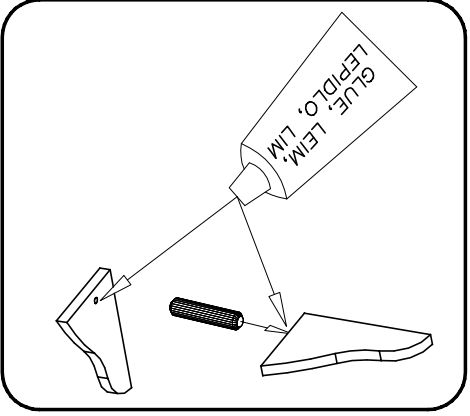
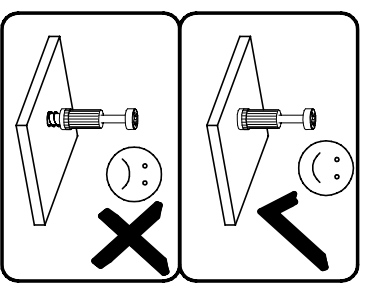
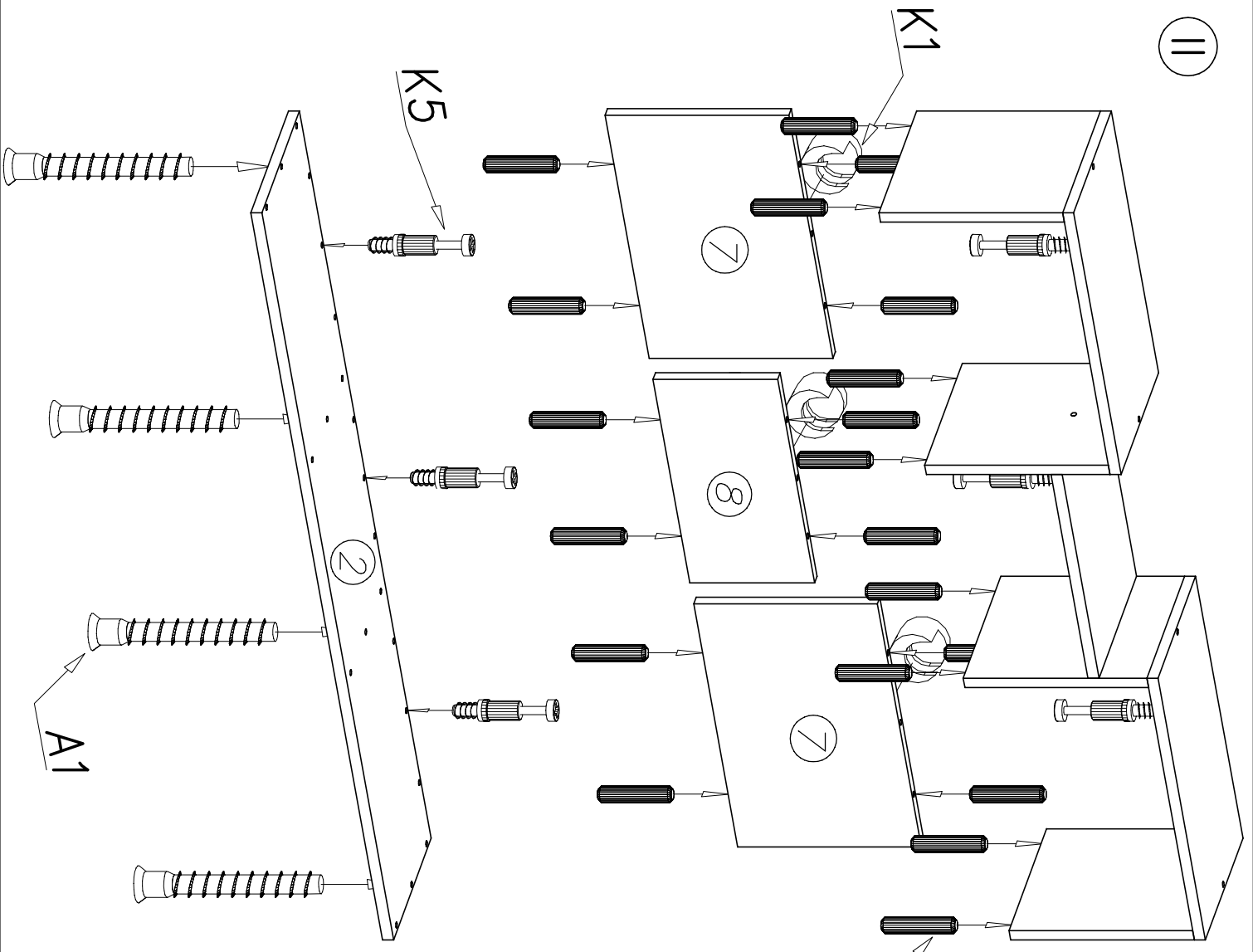

III

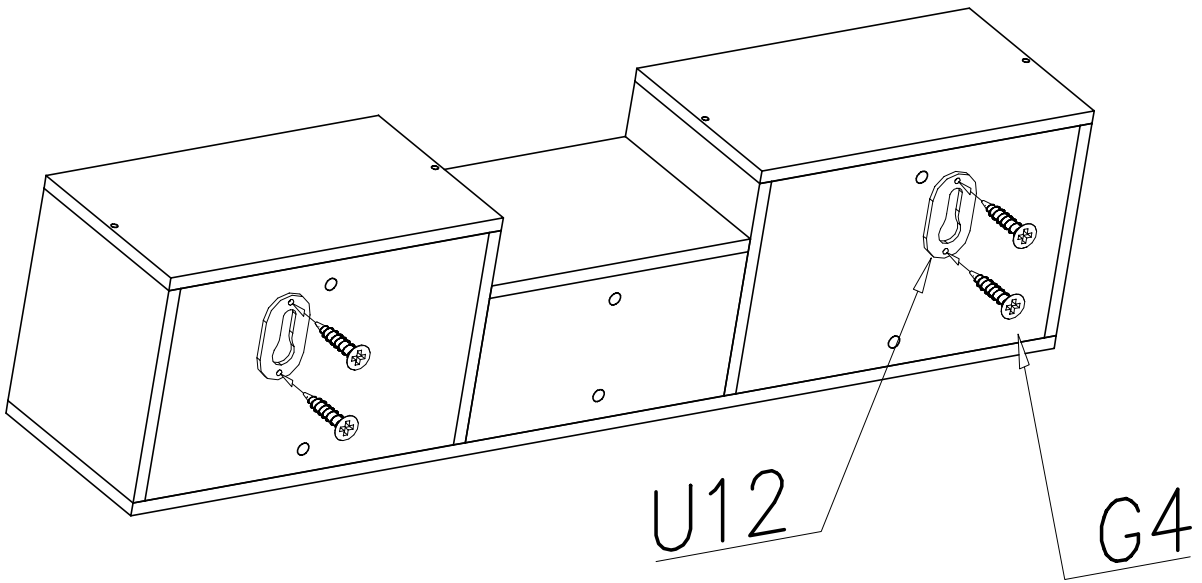

IV

